

MULTICELL HEATERS

MEET YOUR
HIGHEST
DEMANDS



MULTICELL HEATERS

UNIQUE ADVANTAGES FOR DEMANDING OPERATIONS

**MULTICELL HEATERS:
THE HIGH TEMPERATURE CHOICE**

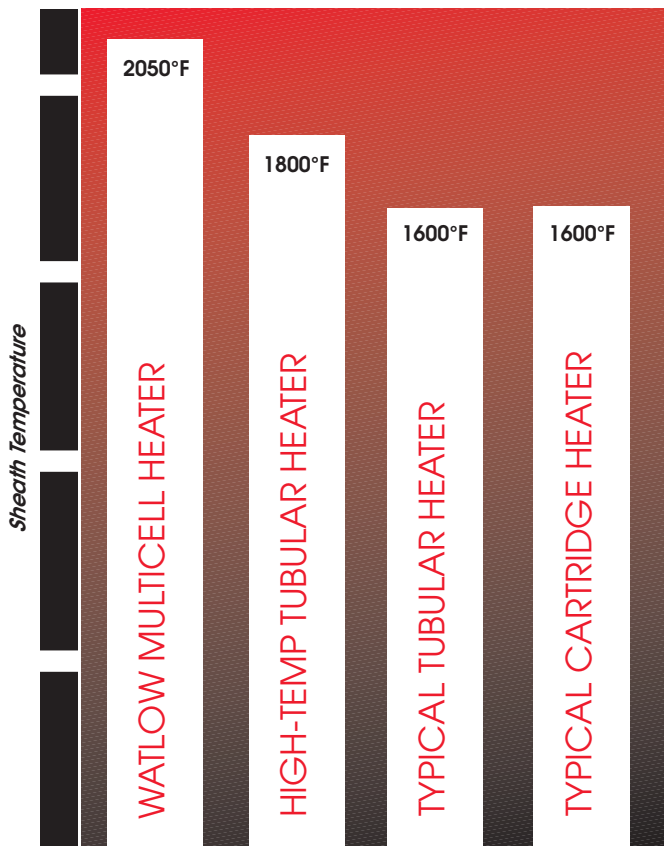

When your processes demand high temperatures and reliable heat, Watlow multicell heaters deliver the performance you need.

Designed to handle applications that demand high voltages and wattages, multicell heaters from Watlow have a rugged construction that permits the heaters to survive in conditions that would normally be lethal to other heater types. These multicell heaters have been engineered to achieve process temperatures up to 1120°C (2050°F) and can satisfy 600 volt.

Watlow's radiant multicell heater design can include up to 10 individual metal-sheathed cells compressed into a larger outer sheath. This double-sheath feature allows efficient heat dissipation, maximum protection against coil oxidation and long life under the most demanding conditions.



This cross sectional drawing of a multicell heater shows six individual metal-sheathed cells. Multicell heaters with up to 10 individual cells are available.



UNIQUE MULTICELL FEATURES FOR DEMANDING APPLICATIONS

- Multiple, independently controllable zones allow **precise process temperature uniformity** not possible with any other single-sheathed heater.
- Allows for replaceable multipoint or singlepoint temperature sensors in internal thermowells for **ease of maintenance** and minimal downtime.
- The heater's radiant design allows for loose insertion into bored holes and pipes. Since it will not bind or seize in the hole, the heater is **easily removed and replaced with minimal downtime**.
- The oxidized sheath provides high emissivity which **improves** as oxidation increases.
- Individual, metal-sheathed coils are compressed into a larger, high temperature alloy outer sheath for **maximum protection against coil oxidation**.
- Satisfies **long length heater** needs providing reduced wiring.

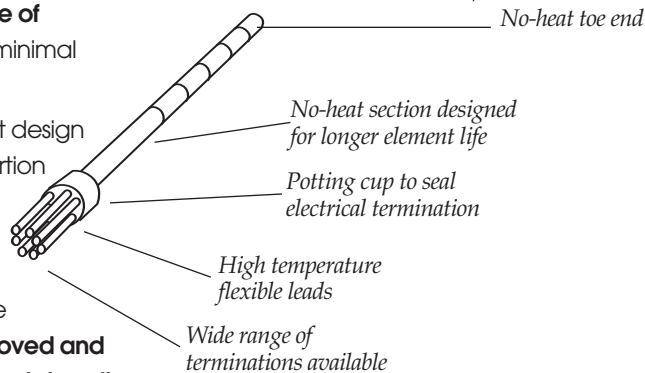
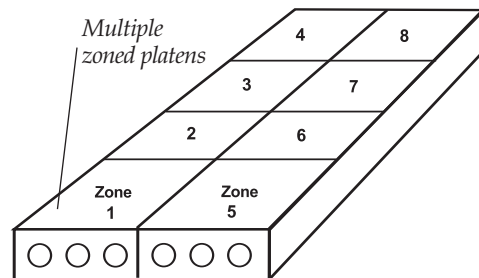

- Quick disconnect plug and jack permit **fast replacement** of individual elements while the equipment stays at operating temperature.
- **Special bending capabilities** solve unusual machinery needs with greater versatility and keep leads away from heated zones.
- Extreme process temperature capability up to 1120°C (2050°F).

MULTICELL APPLICATIONS

Watlow's multicell heaters meet the challenges of the most demanding processes.

- Aluminum processing
- Environmental
- Superplastic forming (SPF)
- Diffusion bonding (SPF-DB)
- Glass forming ovens
- HIPP
- Hazardous waste treatment systems
- Heat treating processes
- Hot forging dies
- Hot gas generation
- Hot isothermal forming
- Molten metal heating

Whether your need is for multiple or single zone control, Watlow's radiant multicell heaters are an excellent heat solution option. Contact your local Watlow representative to find your heating solution today.

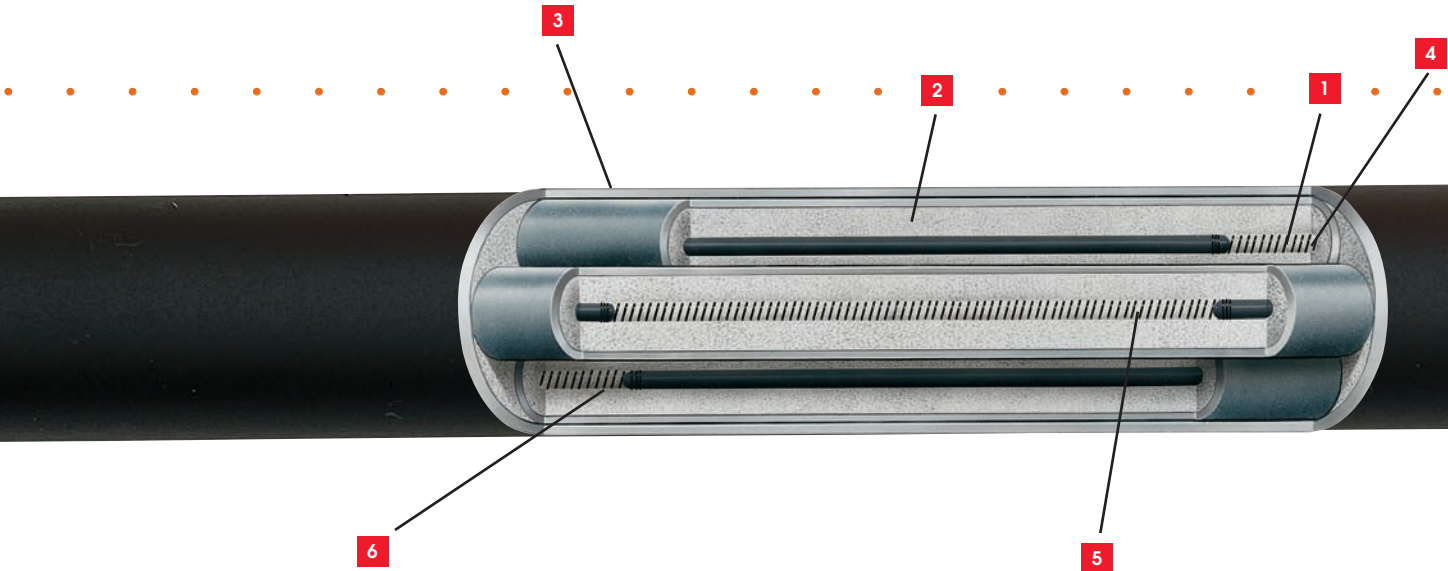

SINGLE ZONE MULTICELL ELEMENTS*

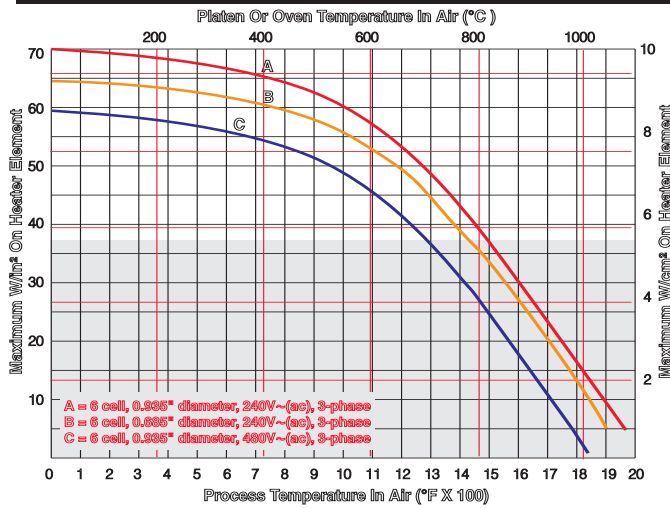

Note: Shaded area is standard. Non-shaded area, consult factory.

THREE ZONE MULTICELL ELEMENTS*

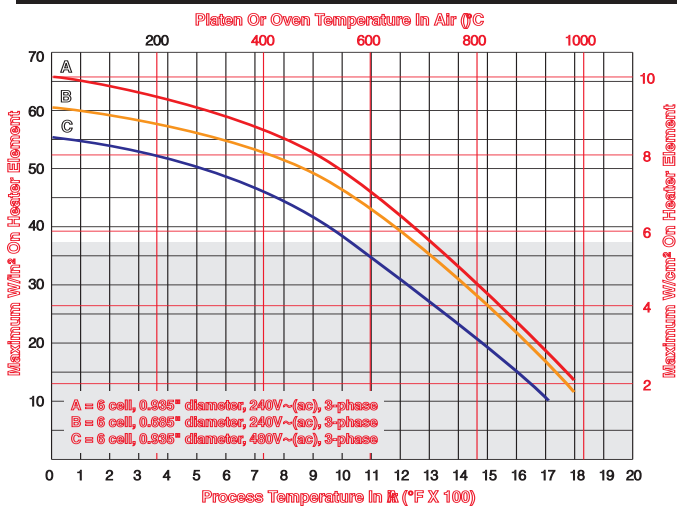

Note: Shaded area is standard. Non-shaded area, consult factory.

* Other designs and voltages with higher temperature capabilities are available. Consult factory.

CASE HISTORY FOR SPECIAL APPLICATION

Challenge: Hot air needed to be heated from 21°C (70°F) to 649°C (1200°F) to test engine parts.

Solution: Watlow designed a compact hot gas generator assembly using a high sheath temperature multicell with an internal thermowell for temperature control. The multicell heater provided the required outlet air temperature at the flow input available, and the thermowell allowed for easy replacement of the thermocouple and a variation thermocouple junction location. Additionally, the customer was able to locate the junction in the hottest area of the process to help prevent premature heater failure.

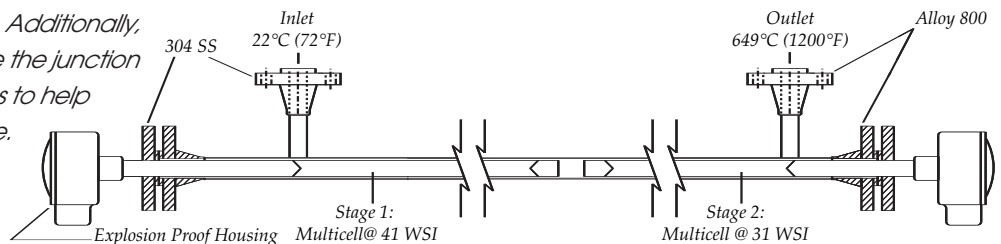

TYPICAL LOOSE FIT SIZES

Standard Multicell Diameter	Platen Hole Size	Minimum Radius Bends
0.685"	3/4" or 7/8"	1.5"
0.935"	1", 1 1/4" or larger	2.5"

Note: See Heaters catalog for bending options.



- 1** Nichrome® (or equivalent) resistance wire
- 2** High grade MgO insulation
- 3** High temperature alloy for outer sheath
- 4** Zone 1
- 5** Zone 2 Separate, independently controllable heated zones
- 6** Zone 3

SHEATH TEMPERATURE AND WATT DENSITIES

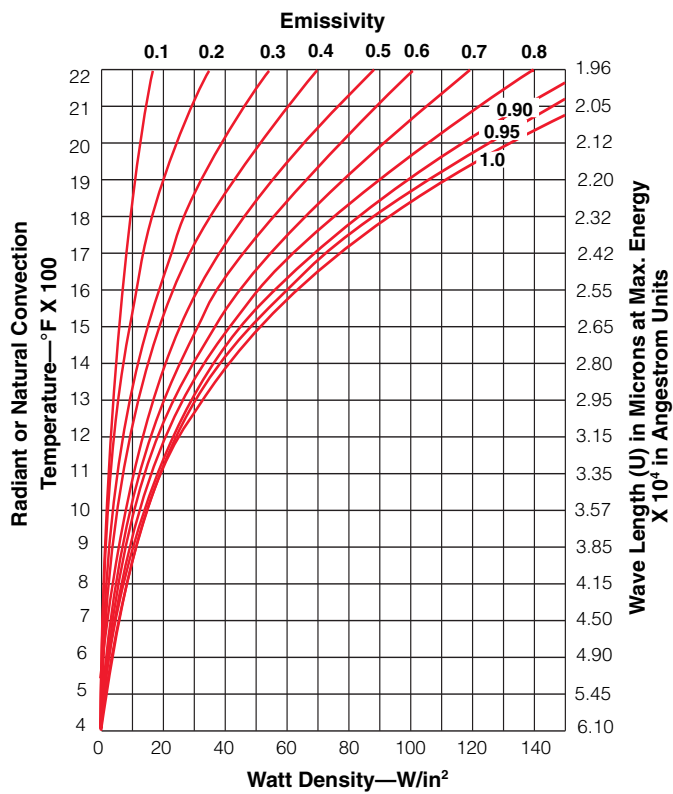

Determining Multicell Process Watt Density and Sheath Temperature: The process watt density is found on the W/in² scale (lower) at the intersection of the process temperature value (left temperature scale) and the 1.0 emissivity curve. The Multicell sheath temperature is found on the left temperature scale at the intersection of the heater emissivity curve (0.90) and the process watt density added to the heater design watt density (lower W/in² scale).

Note: These instructions are for new applications. For existing applications, use the 0.95 emissivity curve to determine sheath temperature, since well-oxidized Multicell heaters are more efficient.

CASE HISTORY FOR CONVENTIONAL USE

Watlow's radiant multicell heaters reduce costly downtime and provide long heater life for glass forming and tempering ovens.

Problem: Plate glass needed to be heated to approximately 704°C (1300°F) to enable bending. The customer was using an oven equipped with open coils in ceramic plates. But during the bending process, some glass would typically break, fall into the open coils and cause them to break. Over time, the glass breakage and coil damage prevented the furnace from achieving process temperature. The furnace would need to be shut down and allowed to cool, before removing the broken coils and ceramic plates. Then new coils and plates could be installed. During this maintenance process, lost production time could last as long as seven days.

Solution: Easy to remove and install multicell heaters from Watlow replaced the coil and ceramic heaters, resulting in minimal downtime and nearly hassle-free maintenance and replacement. Additionally, an internal thermowell with a removable and easily replaced thermocouple was used to enhance and prolong heater life by improving control of the process.

The customer saw these immediate benefits:

- Dramatically reduced downtime
- Longer heater life
- Easy heater and thermocouple replacement for hassle-free maintenance

Contact your Watlow representative today to find out how your problems can be solved.

HOT TOE MULTICELL

A NEW, PATENTED VERSION OF THE MULTICELL HEATER PROVIDES FULL LENGTH HEAT

Watlow's HOT TOE multicell heater provides heat to the full length of the assembly for optimum heat distribution and extended heater life. The patented design eliminates the unheated section found at the end of standard multicell constructions. This feature allows for optimum heat distribution with a lowered watt density for shorter length designs. By heating the full section of the unit, temperatures for internal wires are lower, therefore, improving heater life.

Due to the design of the HOT TOE multicell, ground fault isolation over the heated portion can also provide improved heater safety.

Watlow's HOT TOE multicell heaters achieve process temperatures up to 1037°C (1900°F) and satisfy 240 volt, single-phase power requirements. The HOT TOE Multicell is designed for single-zone applications.

UNIQUE FEATURES OF HOT-TOE MULTICELL

- Provides heat to the full length of the assembly for **optimum heat distribution**.
- **Improves heater safety** with ground fault isolation over the heated section.
- Provides **extended heater life**.
- High temperature alloy outer sheath material and a special internal construction ensure **high temperature performance** and **corrosion protection** in static air applications.
- Available in 0.935-inch diameter for **easy retrofit** in existing tubular designs that may be experiencing short life.

PERFORMANCE CAPABILITIES

- Sheath temperature to 1037°C (1900°F).
- Single phase, single zone, 240 volts
- Single-ended termination lead wires can be installed into flanges and screw plugs similar to standard product configurations.
- Bendable in standard multicell configurations for a wide variety of applications.



APPLICATIONS

- SPF single-zone platens
- Radiant heating
- Drying
- Environmental – VOC abatement
- Process air heating: duct heaters, circulation heaters
- Vacuum
- Flue gas cleaning (desulfurization)
- Fluidized beds
- Light metals extrusion

PLATEN OR OVEN TEMPERATURE IN AIR (°C)

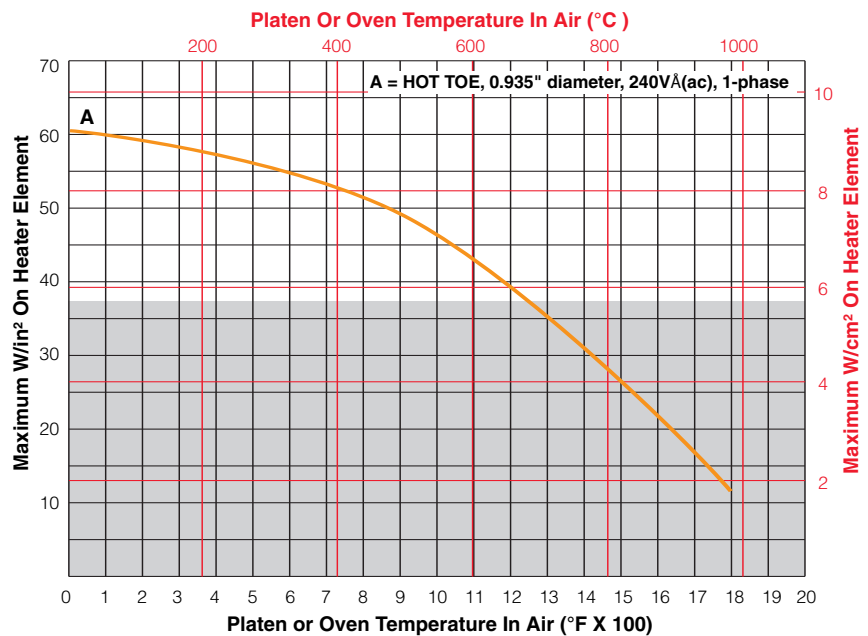

This chart should be used to verify the correct watt density for a platen or oven application assuming no air flow. To use the chart, select platen or oven temperature from X axis. Find intersection with curve A. Determine maximum watt density by reading left or right to intersection with Y axis.

Note: Shaded area is standard. Non-shaded area, consult factory.

* Other designs and voltages with higher temperature capabilities are available. Consult factory.

HOT TOE MULTICELL SPECIFICATIONS

Diameter	Bending	Sheath Length	Minimum No-Heat Length	Total Heated Length
		Min./Max.	in. (mm)	Min./Max.
0.935	Consult Factory	12 (305)/66 (1676)	2 (51)	10 (254)/64 (1626)



Watlow Products and Technical Support Delivered Worldwide

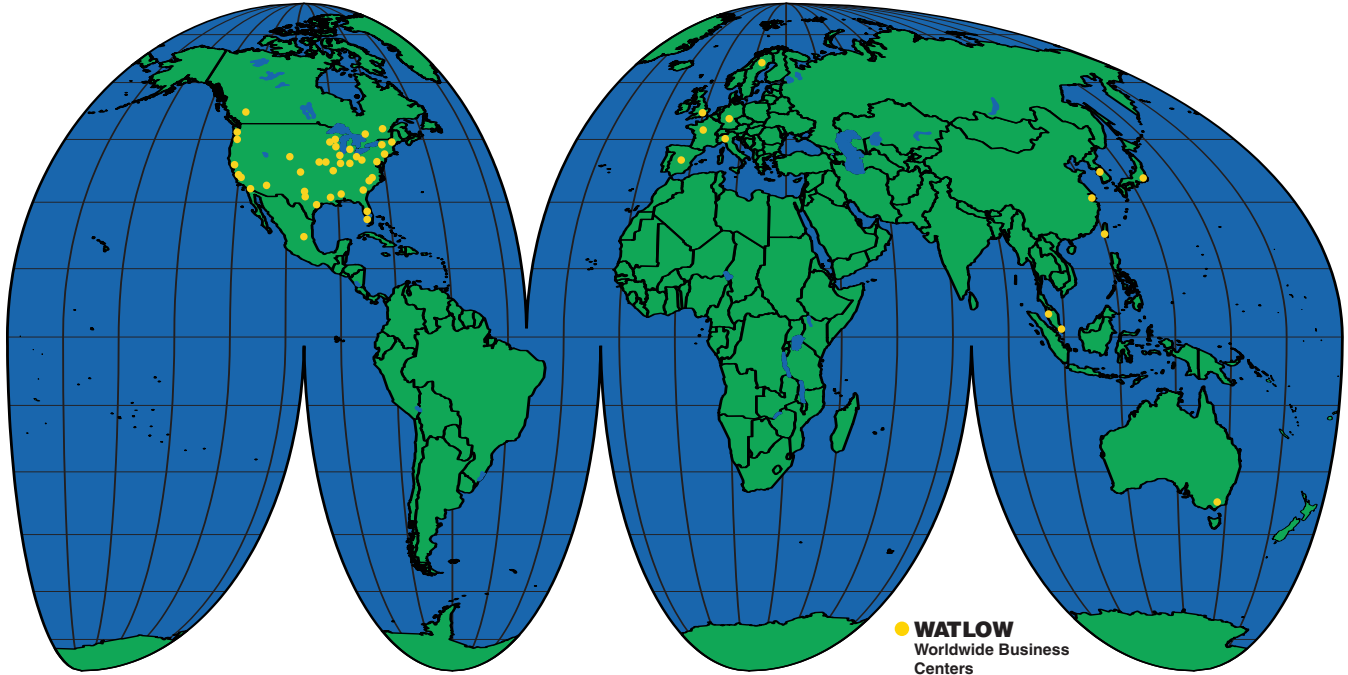

● **WATLOW**
Worldwide Business
Centers

Asian Technical Support & Sales Offices

Australia	+61-3-9335-6449
China	+86-21-3950-9510
Japan	+81-3-3518-6630
Korea	+82-2-575-9804
Malaysia	+60-3-7980-7741
Shanghai	+86-21-3950-9504
Singapore	+65-6773-9469
Taiwan	+886-7-288-5168

European Technical Support & Sales Offices

France	+33 (01) 3073-2425
Germany	+49 (0) 7253-9400-0
Italy	+39 (02) 458-8841
Sweden	+46 35 27 11 66
United Kingdom	+44 (0) 115-964-0777
Spain	+34 916 751 292

Latin American Technical Support & Sales Office

Mexico	+52-442-217-6235
--------	------------------

North American Technical Support & Sales Offices

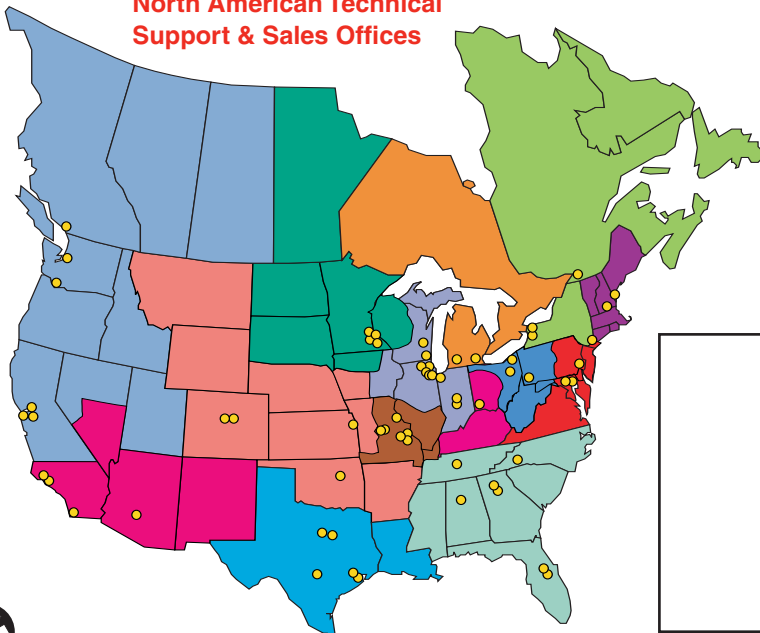

To be automatically connected to the sales office nearest you call:

1-800-WATLOW2

Your Authorized Watlow Distributor is:

