

PUR-X 1000

Circulation Heater

The CAS PUR-X replaceable tube circulation heater provides contamination-free heating of liquids and gases.



TARGET MARKETS

- Semiconductor solvent heating
- High-purity liquid heating

SPECIFICATIONS

- **PUR-X 1000:** 1.5kW – 4.5kW, 120V, 200V, 208V, 220V, 230V, 240V, 380V, 400V, 415V
- Explosion resistant (NEMA 7) electrical enclosure
- Tubing, .375" (3/8") O.D. x .031" wall, field replaceable
 - Standard PFA
 - High purity PFA, SEMI F57 compliant
 - 190" Long (15.8ft or 4.8m)
 - Tube size & length are the same for both standard PFA & high purity PFA
- Body: Aluminum 319, Teflon[®]-coated
- Maximum operating temperature: 200°C (392°F)
- Two sensors, for process control and process high-limit, choice of J or K type thermocouples
- Third sensor (J or K type, matching the selected process sensors) for casting & tube protection. Requires independent high limit control loop set no higher than 235°C (455°F)
- Optional insulation jacket
- Optional fittings, PFA 3/8" Straight Union, SEMI F57 compliant
- 70 psi max (480 kPa)

Size and Weight:

- PUR-X 1000: 4.3" O.D. (10.9cm) x 16.5" (41.9cm) tall, 22 lbs (9.9Kg) (includes housing)

APPLICATIONS

- Semiconductor wet process systems
- Wafer cleaning equipment (wet bench systems)
- Heating of photo-resist removal solvents
- DI water heating for wafer rinsing
- Air and Nitrogen heating for wafer drying
- Acid heating

FEATURES/BENEFITS

- Heating elements cast in aluminum
- Low maintenance
- Teflon[®]-coated for easy cleaning
- High purity heating
- Fluid path independent of heater sheath
- Non-welded construction
- Self-draining
- Replaceable tubing



PUR-X 1000

Circulation Heater

TECHNICAL DRAWING

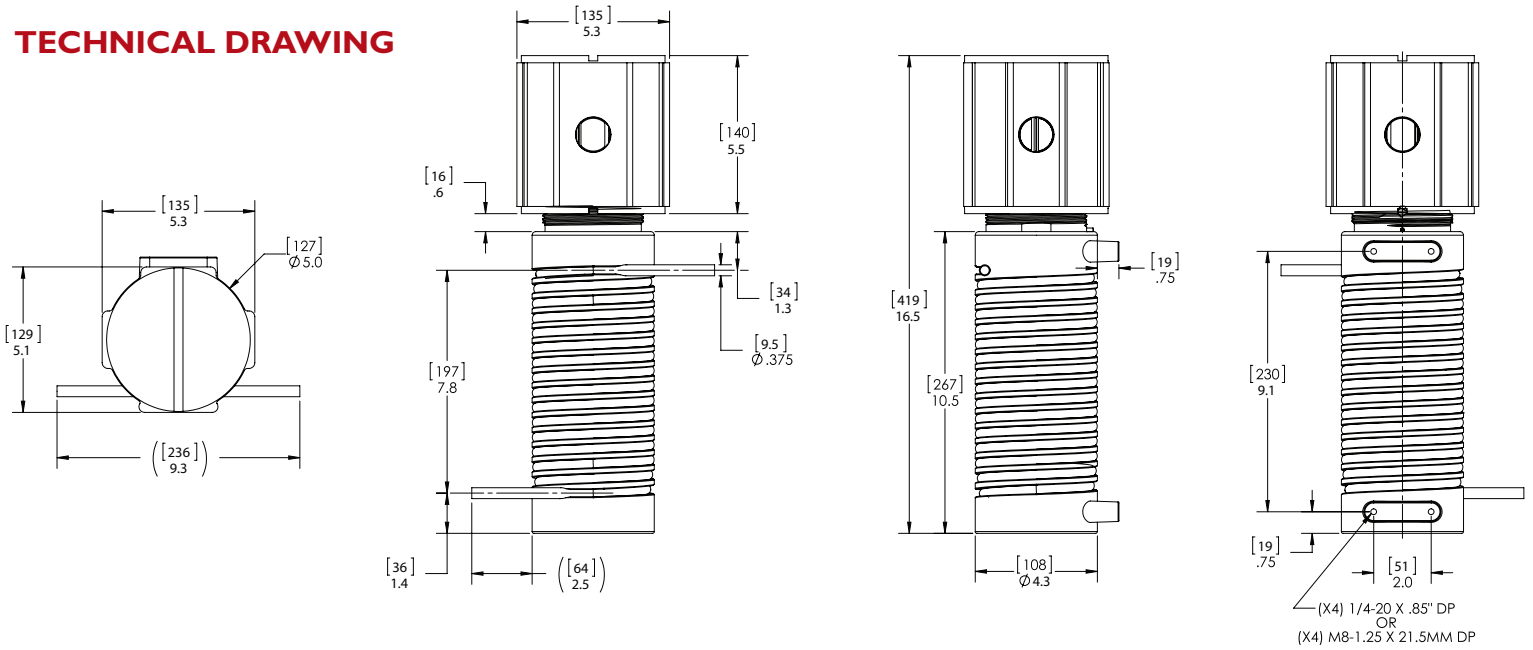

HEATING PROFILE (water) Inlet water 15°C (59°F) at 200°C (392°F) set point with insulation jacket.

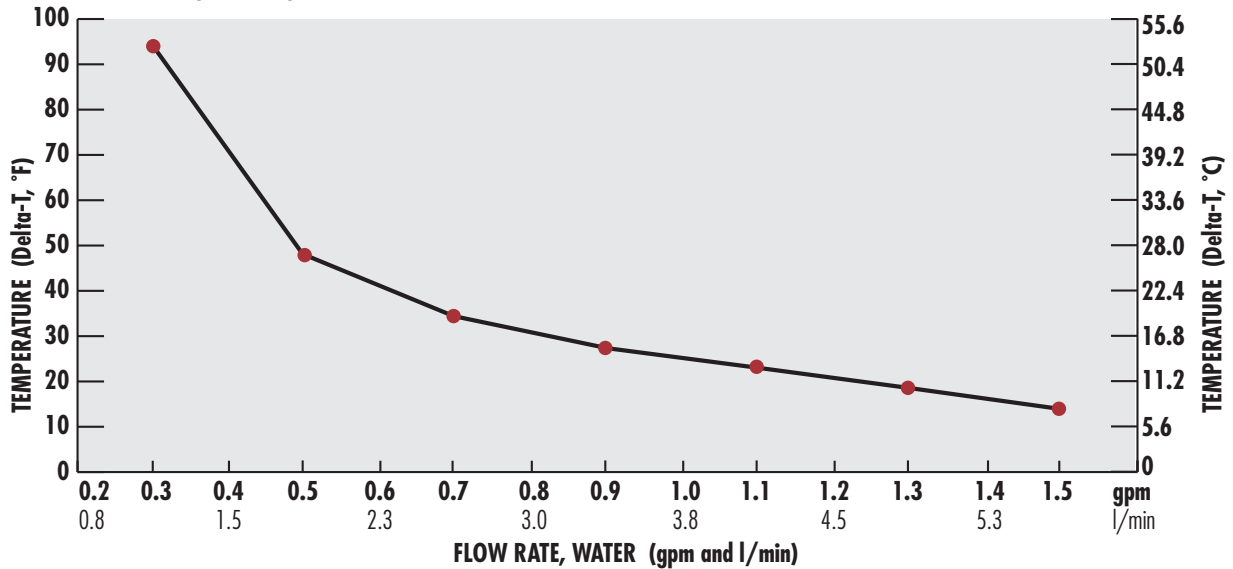

PRESSURE DROP PROFILE (water)

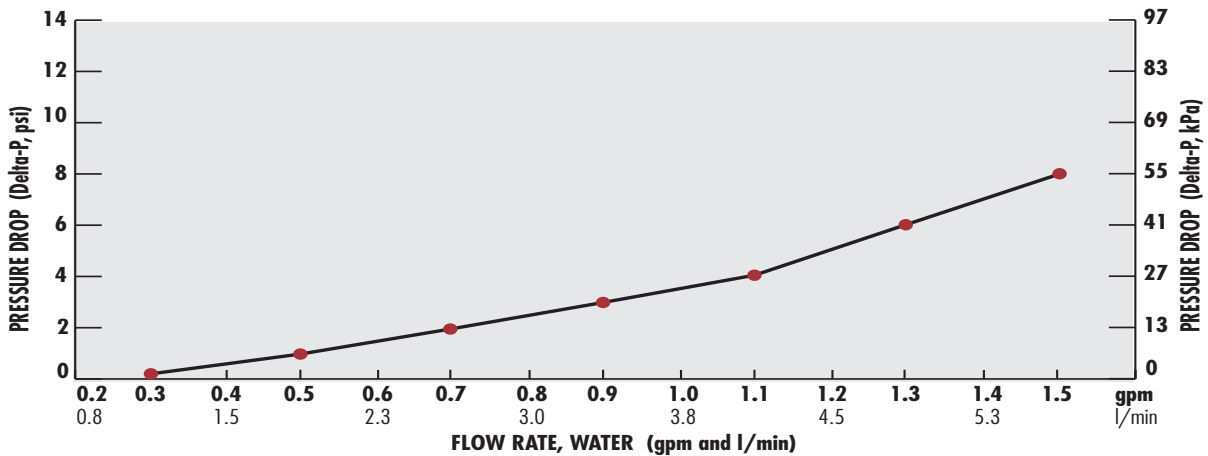

ORDERING INFORMATION

BASE CIRCULATION HEATER		
NEMA 7 ENCLOSURE		
HEATER WATTAGE		
10 = 240V, 3-phase delta circuit 4.2kW 10.1 Amps	Choose One	
11 = 208V, 3-phase delta circuit 3.1kW 8.8 Amps		
12 = 415V, 3-phase wye circuit 4.1kW 5.8 Amps		
13 = 400V, 3-phase wye circuit 3.8kW 5.6 Amps		
14 = 380V, 3-phase wye circuit 3.5kW 5.3 Amps		
15 = 200V, 1-phase, 2.9kW 14.6 Amps		
16 = 208V, 1-phase, 3.1kW 15.2 Amps		
17 = 220V, 1-phase, 3.5kW 16.0 Amps		
18 = 230V, 1-phase, 3.8kW 16.8 Amps		
19 = 240V, 1-Phase, 4.2kW 17.5 Amps		
20 = 208V, 3-phase wye circuit 4.5kW 12.5 Amps		
21 = 120V, 1-phase 1.5kW 12.5 Amps		
22 = 120V, 1-phase 3.0kW 25 Amps		
TUBE MATERIAL		
00 = Standard PFA tubing 3/8" O.D., .031" wall thickness		
01 = High Purity PFA tubing 3/8" O.D., .031" wall (SEMI F57 compliant)		
SENSOR		
JJ = J type thermocouples		
KK = K type thermocouples		
ACCESSORIES (ordered separately, loose packed)		
274-131-1-3 (PFA fitting 3/8" Straight Union, SEMI F57 compliant) 2 pieces		
307-0-18-1 (Insulation Jacket) 1/2" fiberglass insulation, Teflon®- coated fiberglass outer cover (rated to 550°F/288°C), Red silicone impregnated fiberglass inner liner, velcro flap fastening, H.T. construction.		
515-68-1-5 replacement PFA tube		
515-68-1-7 replacement HP PFA tube		

PX10-



PUR-X 1000
with insulation jacket

WIRING DIAGRAMS

3-PHASE DELTA CIRCUIT

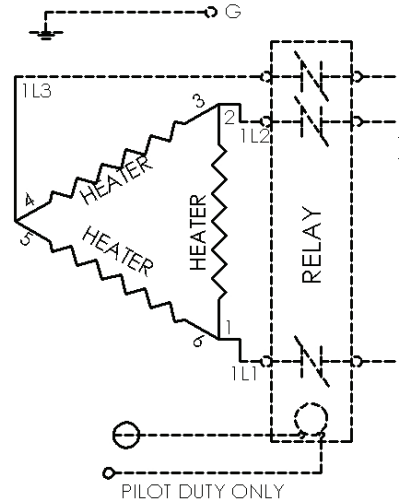

3-PHASE WYE CIRCUIT

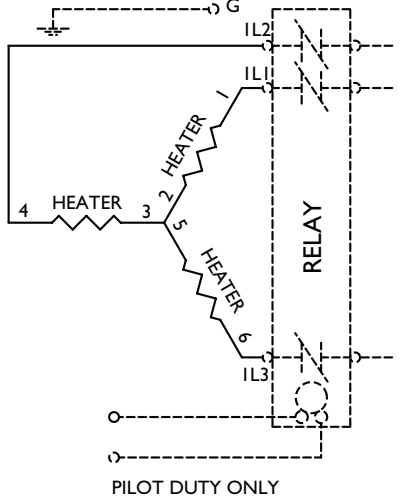

1-PHASE CIRCUIT

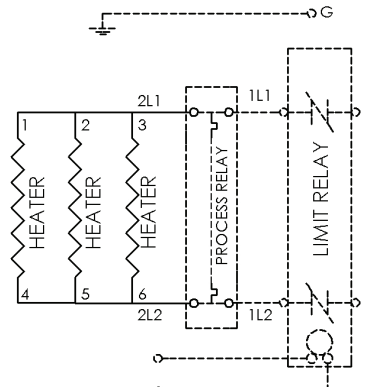

HEATING PROFILE (air) Inlet air at 21°C (70°F) and 70psi; 200°C (392°F) set point with insulation jacket.

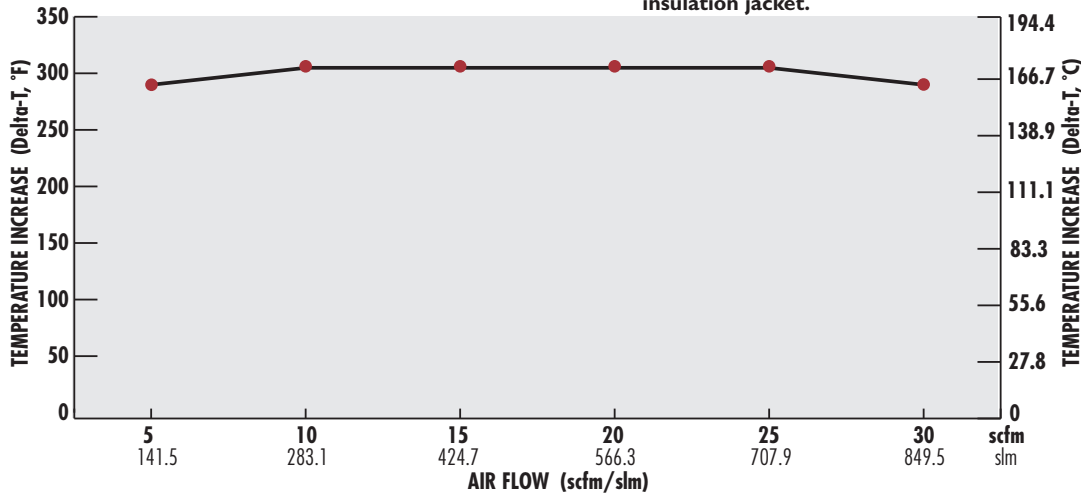

PRESSURE DROP PROFILE (air)

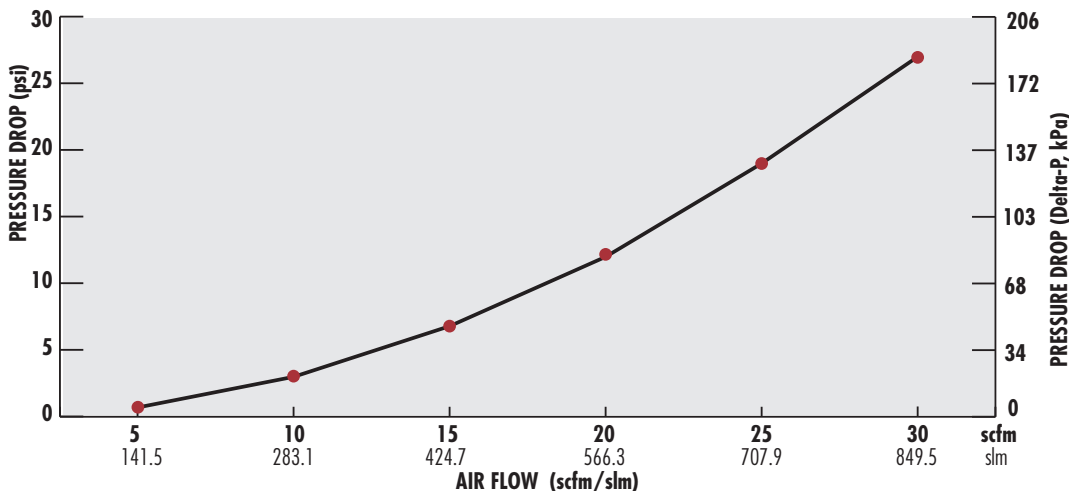

PUR-X 1000

Circulation Heater

COMPETITOR COMPARISON

ATTRIBUTE	PUR-X	COMPETITIVE PRODUCT
Enclosure	Explosion resistant (NEMA 7) electrical enclosure	Requires inert gas purging
Max temperature	200°C (392°F)	180°C (356°F)
Heater element/ construction	Tubular heating element, cast into aluminum 319. No contact with fluid.	PTFE-sheathed element, in contact with fluid.
Insulation jacket	Optional	Not available
Fluid path	Field-replaceable PFA tubing	Not an isolated fluid path - Body and heater element are in contact with fluid

U.S.A. SALES REPRESENTATIVES

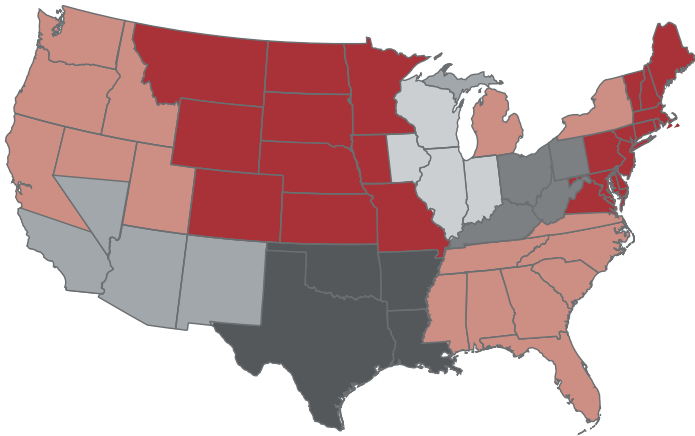

San Francisco
tel: 408-754-3370

Los Angeles
tel: 714-935-2999

Texas
tel: 972-620-6030

**MIDWEST &
WEST CENTRAL CANADA**
tel: 952-892-9222

Chicago
tel: 847-458-1500

**GREAT LAKES,
EASTERN &
CENTRAL CANADA**
tel: 248-651-0500

NORTHEAST
tel: 215-345-8130

SOUTHEAST
tel: 573-754-4806

OHIO VALLEY
tel: 513-398-5500

INTERNATIONAL SALES REPRESENTATIVES

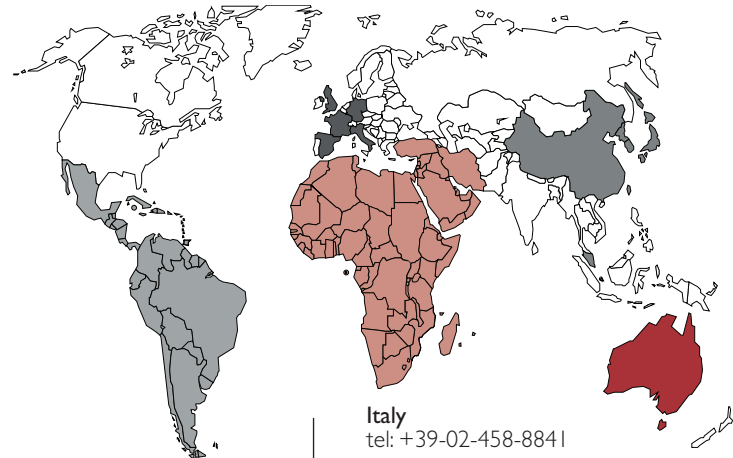

Italy
tel: +39-02-458-8841

Spain
tel: +34-91-675-1292

United Kingdom
tel: +44-115-964-0777

SOUTHEAST ASIA
China
tel: +86-21-3532-8532

Japan
tel: +81-3-3518-6630

Korea
tel: +82-2-2169-2600

Singapore
tel: +65-6773-9488

Taiwan
tel: +866-7-288-5168

India
tel: +91-40-234-12216

AMERICAS
Mexico
Central America
South America
tel: +52-442-256-2200

**AFRICA
MIDDLE EAST**
tel: +20-2-388-9574

AUSTRALIA
tel: +61-3-9335-6449

EUROPE
France
tel: +33 (0) 1-41-32-79-70

Germany
tel: +49-7253-9400-0



CAST ALUMINUM

Solutions

1310 Kingsland Drive Batavia, Illinois 60510 Phone: 888-367-3992 CAS@CastAluminumSolutions.com www.CastAluminumSolutions.com